

Installazione

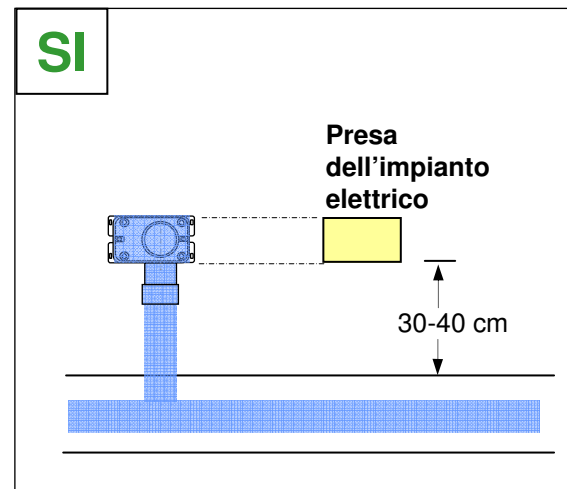

Installazione

SI

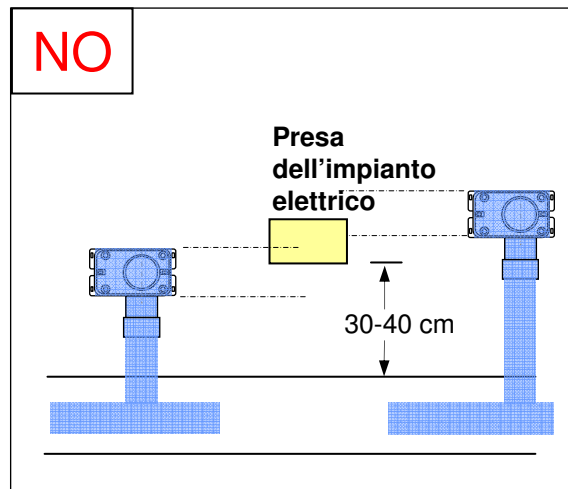
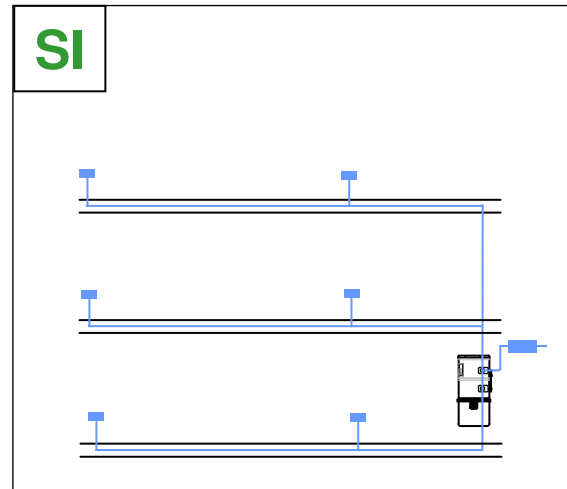
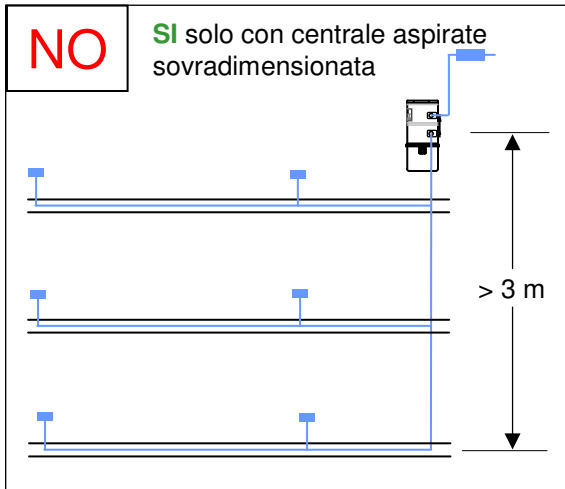
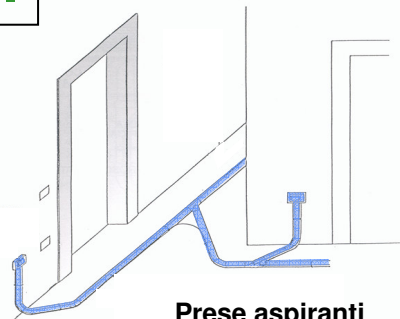

Prese aspiranti vicino a stipiti delle porte

NO

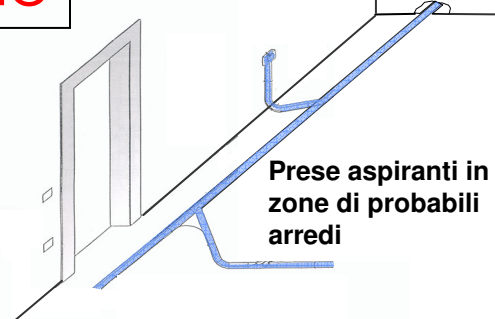

Prese aspiranti in zone di probabili arredi

SI

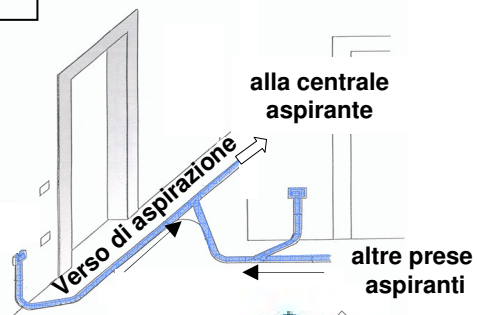

Derivazioni montate in modo corretto

NO

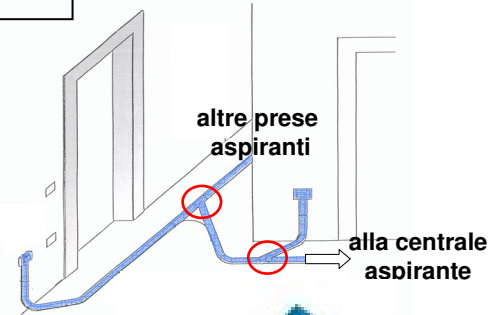

Derivazioni montate in modo errato

Installazione

SI

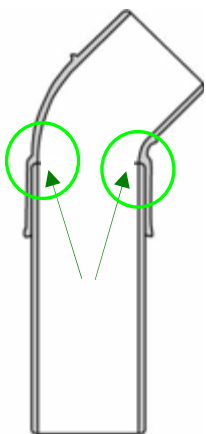

Raccordi in battuta perfetta
- SENZA dislivelli interni -

SI

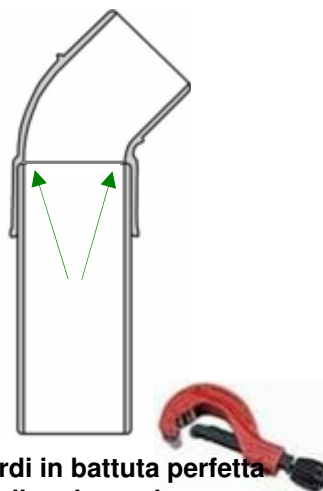

Raccordi in battuta perfetta
- Tubo tagliato in modo corretto -

SI

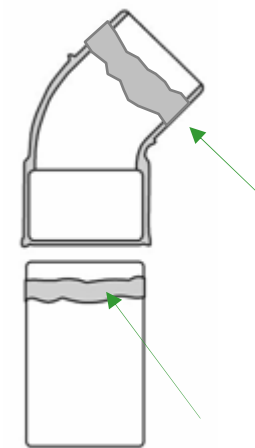

Mastice posizionato in modo
corretto

NO

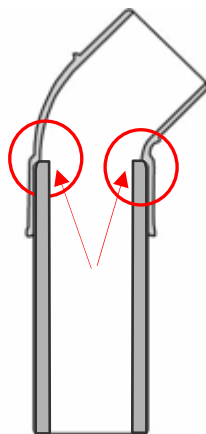

Raccordi in battuta imperfetta
- CON dislivelli interni -

NO

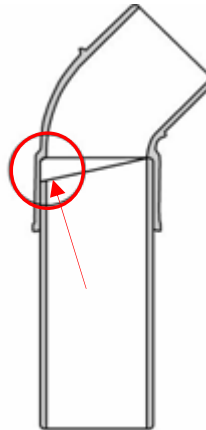

Raccordi in battuta imperfetta
- Tubo tagliato in modo errato -

NO

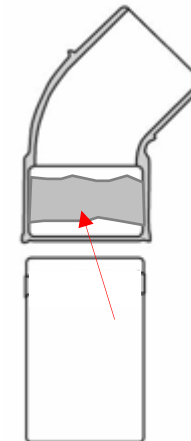

Mastice posizionato in modo
errato